

COIN PURSE

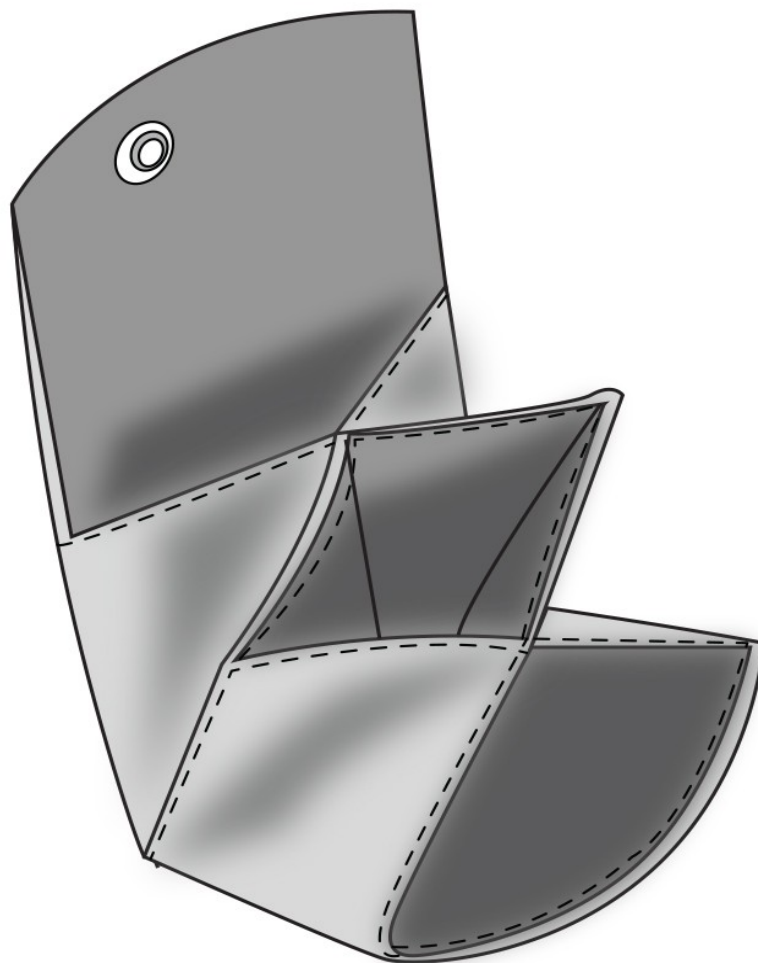
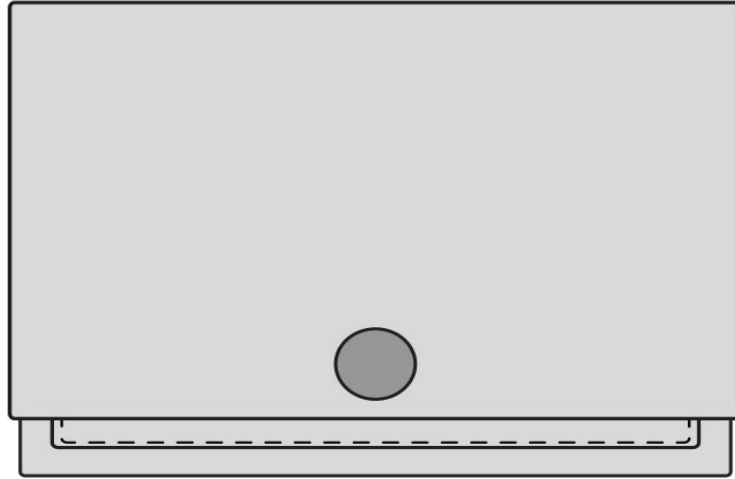

This purse is ideal to carry some change with you as well as credit cards. It is perfect for kids to carry their pocket money. :)

FABRIC RECOMMENDATION: Any medium weight cottons will do. You need one colour for the lining and one for the main. You can use the same fabric as well. You will also need rather firm interfacing – glue on or sew on.

MATERIALS:

1. Two pieces of cotton fabric (main and lining) 32x25cm
2. Firm interfacing piece 32x25cm
3. Regular machine needle size 80/12.
4. One snap or button

SEWING INSTRUCTIONS:

1. You can watch my video tutorial on how to assemble the purse on YouTube: https://www.youtube.com/watch?v=55_yihq0FGY However, if you prefer written instructions please follow the steps below.
2. Interface the main fabric.
3. Put the lining and the main fabric right side of the fabric together.

Lining, right side of the fabric up

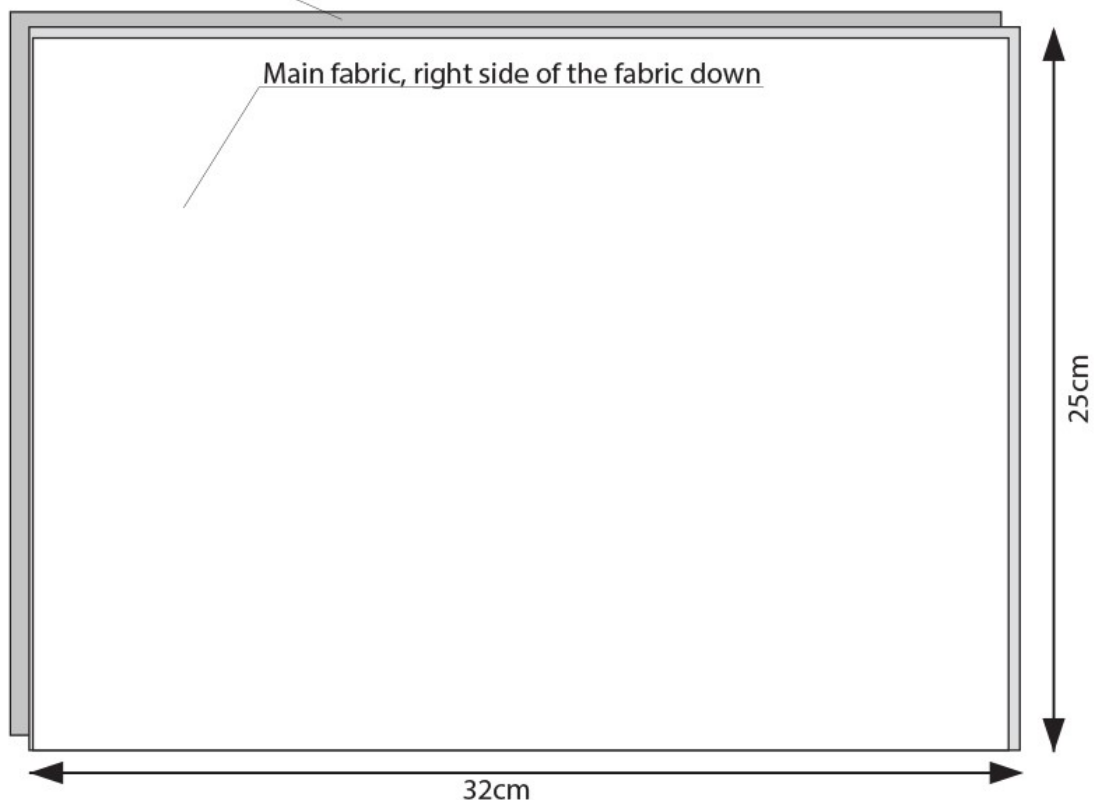

4. Mark as follows: 1cm seam allowance from all four sides first, then draft two rectangles 10x8cm in two corners. See below.

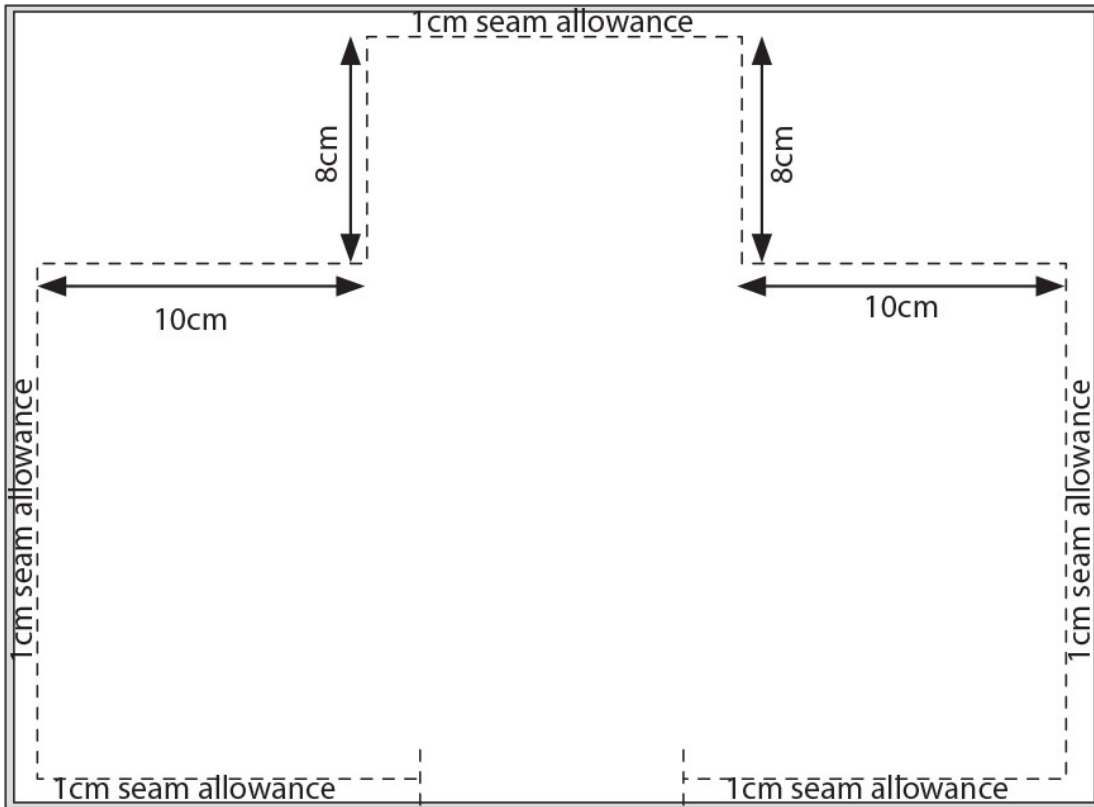

Stitch along the marked line leaving a gap to turn inside out.

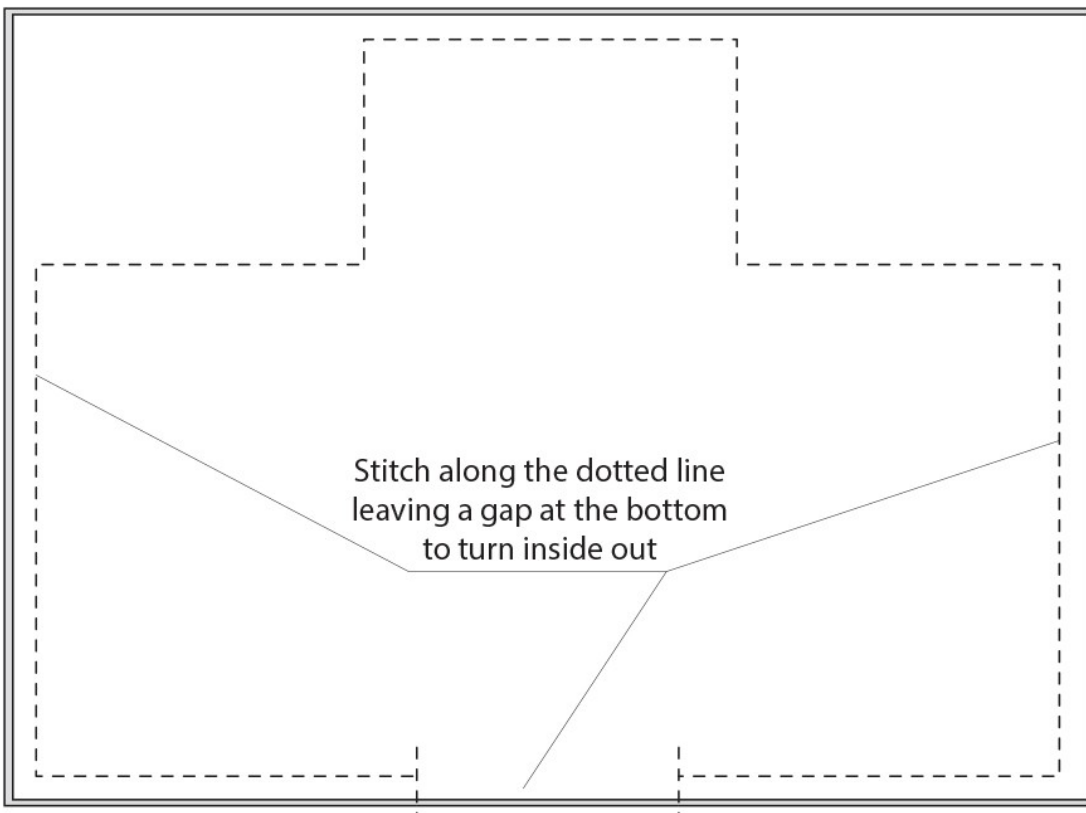

- Cut away the corner rectangles and stitch them 1cm from the edge also leaving a gap to turn inside out.

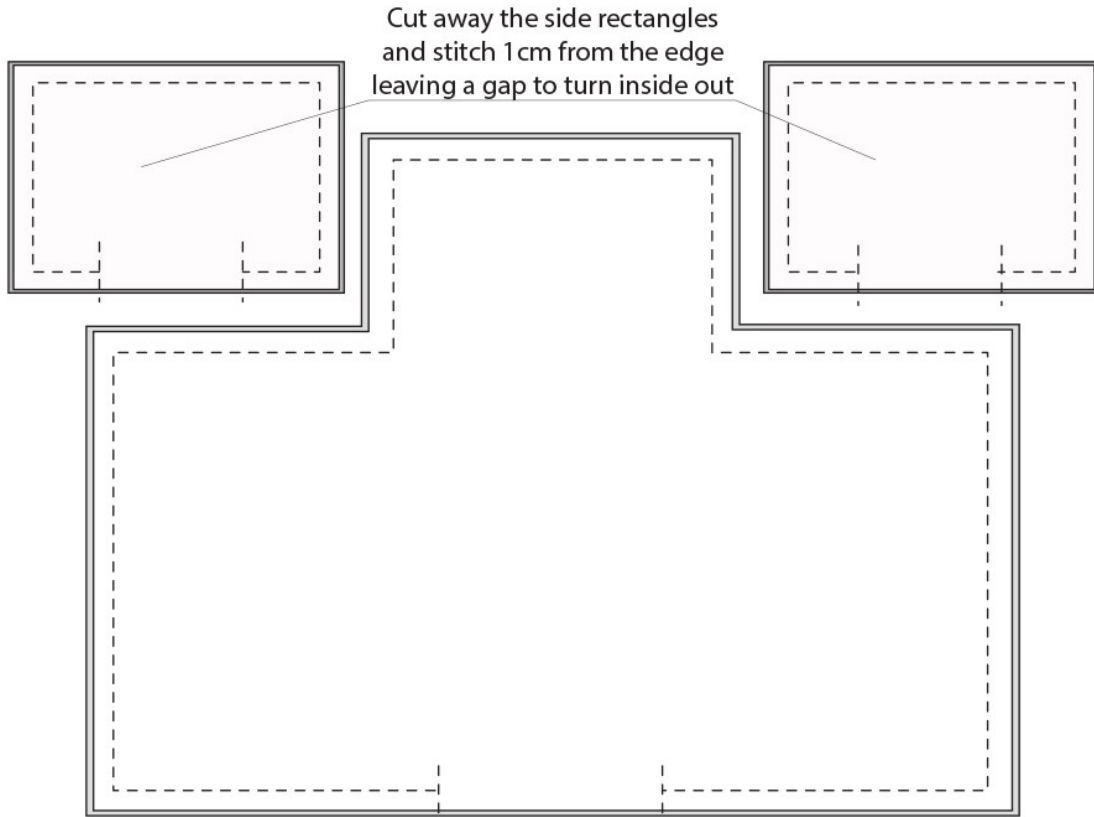

- Cut away all the corners. Be careful not to cut through the stitching, leave about 1mm of fabric at the stitched corners. Cut into the purse flip corners stopping 1mm from the stitching.

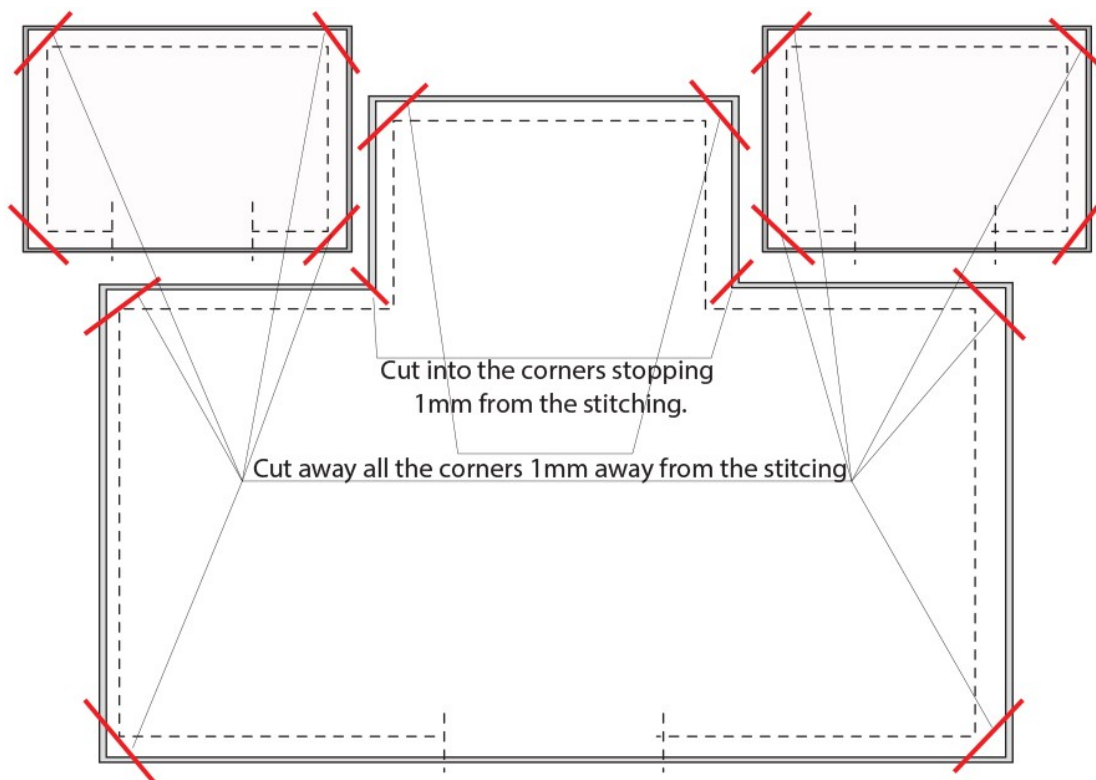

7. Turn inside out, press with hot iron. Stitch 1mm from the edge along the side with the gap to close it.

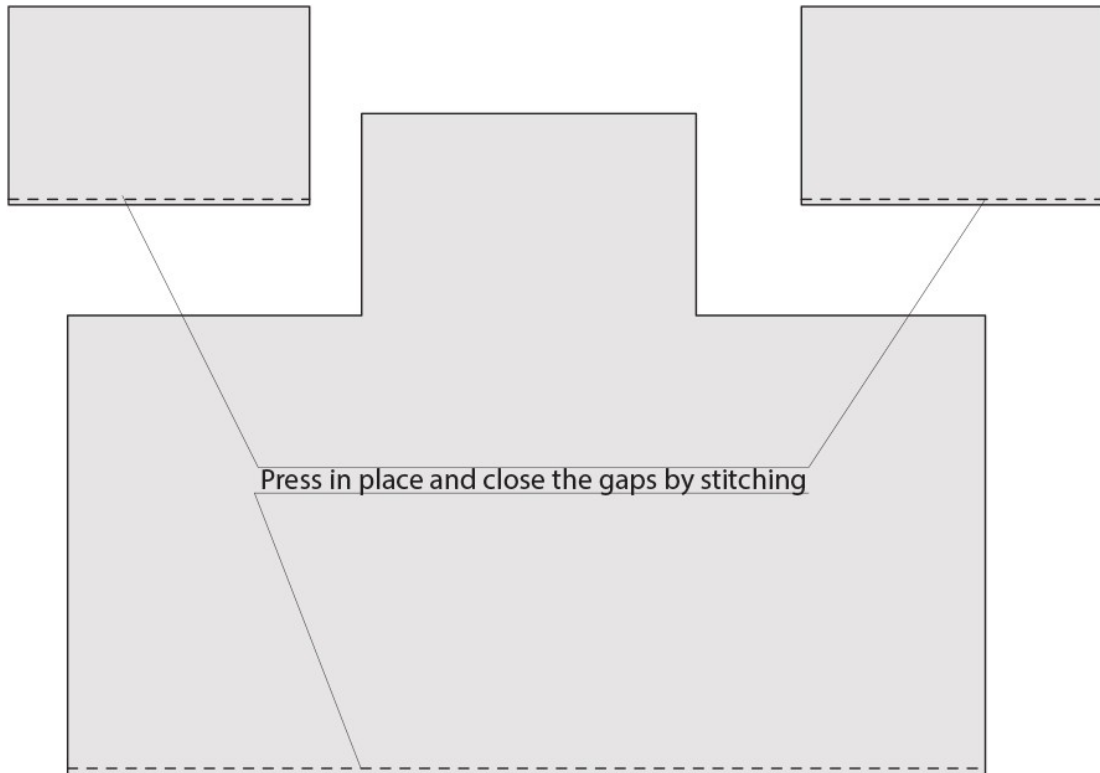

8. Take the large piece of fabric and fold as shown below. Press in place.

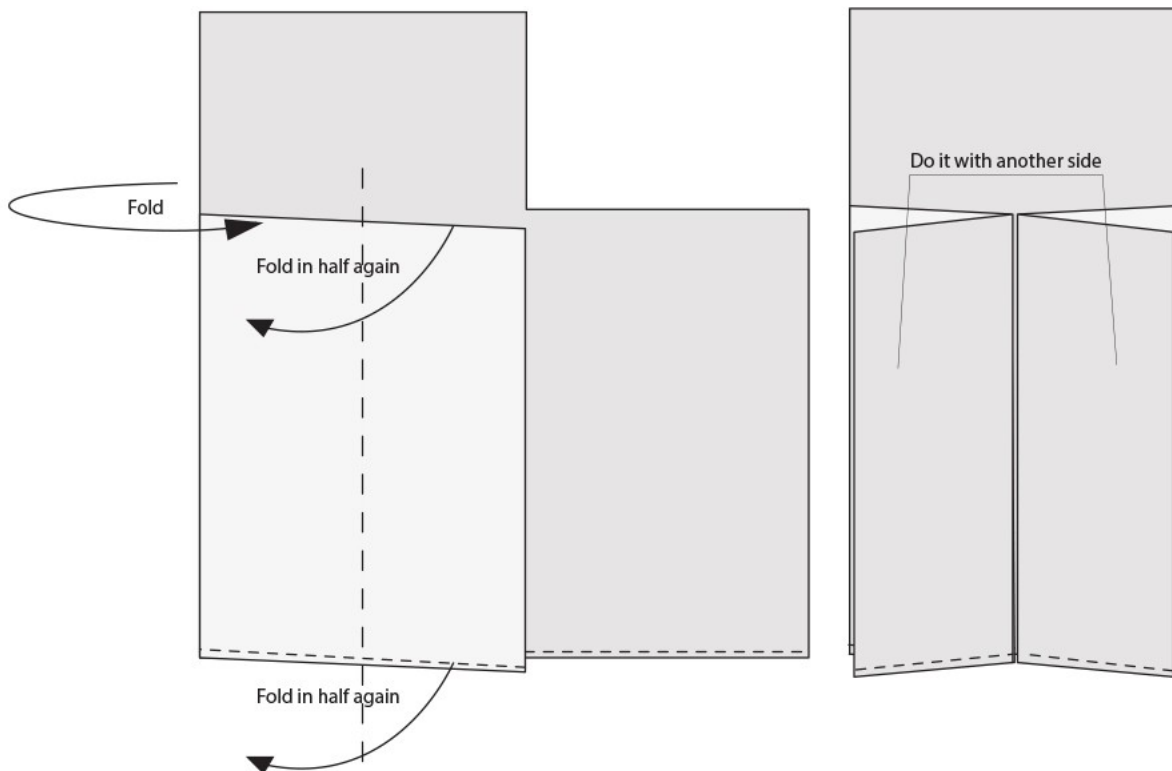

9. Turn around so that the folded ends are below. Place the pockets and stitch them to the purse. Make sure pocket openings are facing the opposite directions.

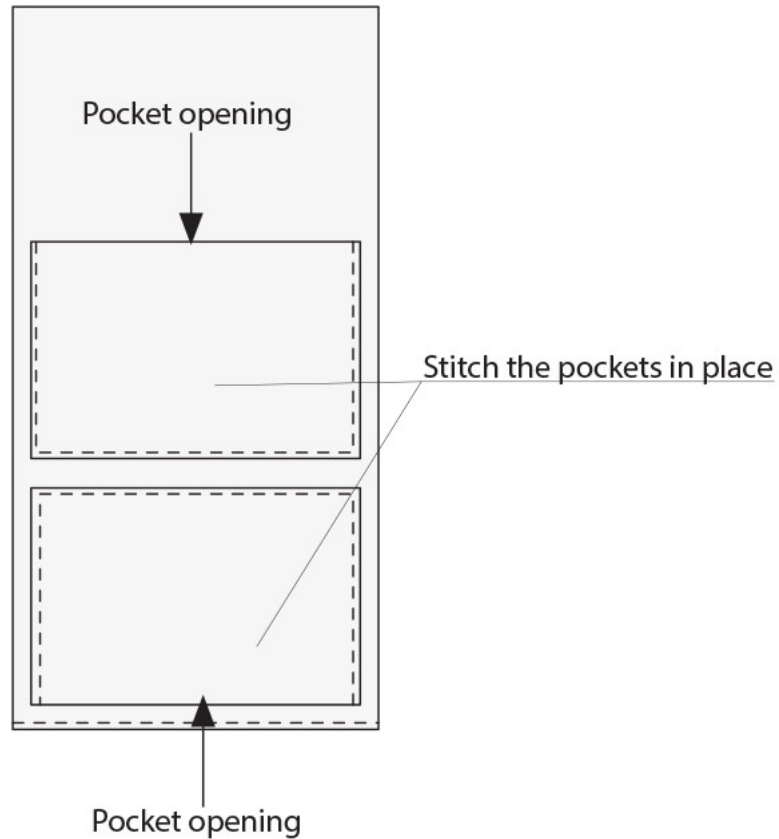

10. Turn the purse around again. Fold as shown below and stitch along the fold.

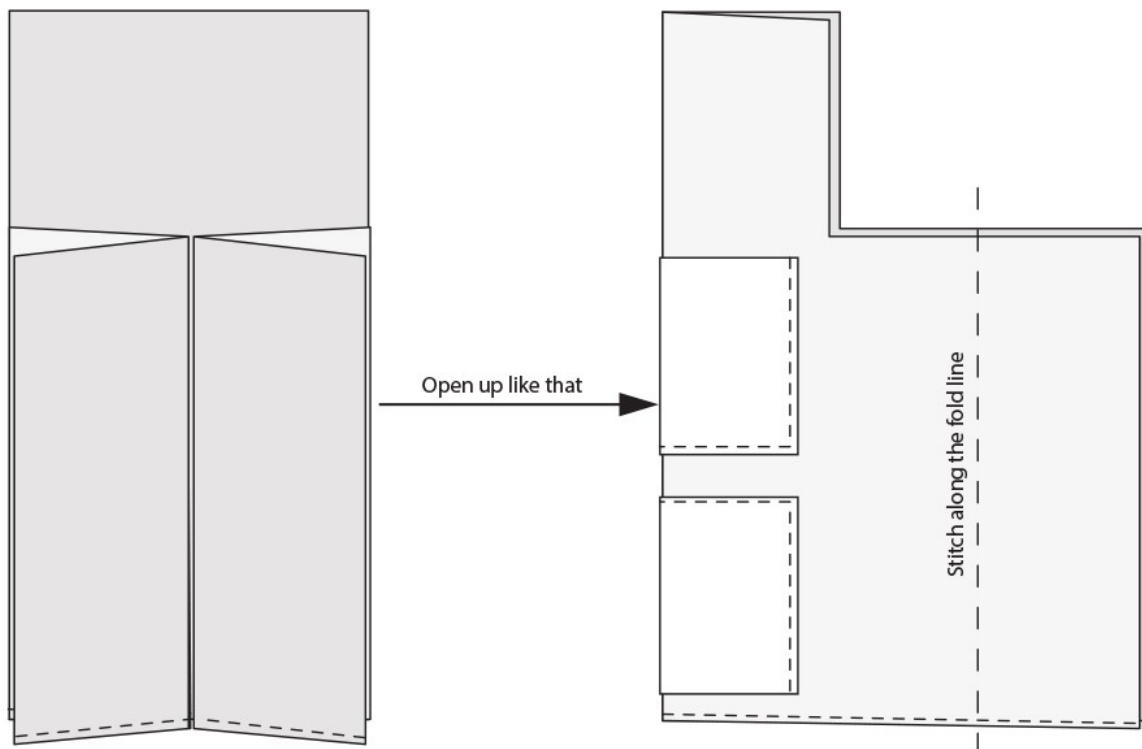

11. Fold one edge as shown below. Fold the purse in half.

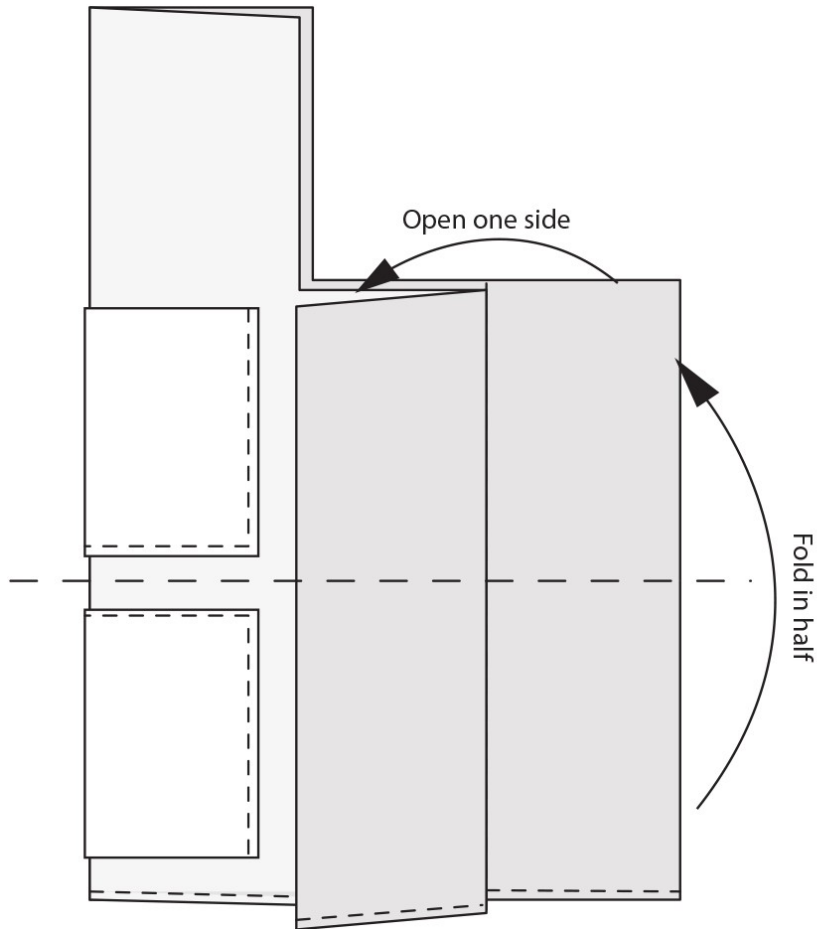

12. Stitch 1mm from the edge as shown below. Drag the other side out and stitch it as well.

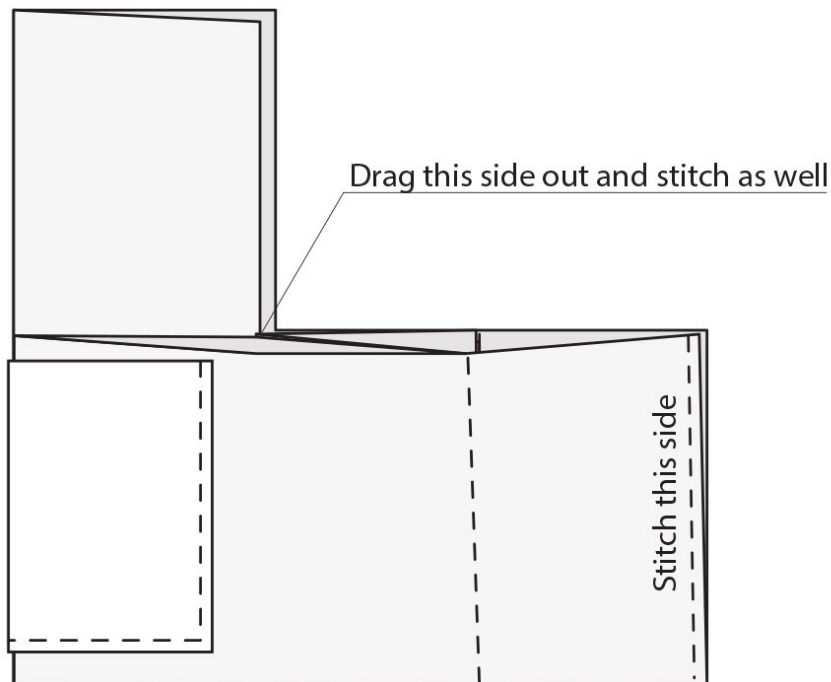

13. Now twist the purse into position by straightening the back of it. It should look like that from the back (see below).

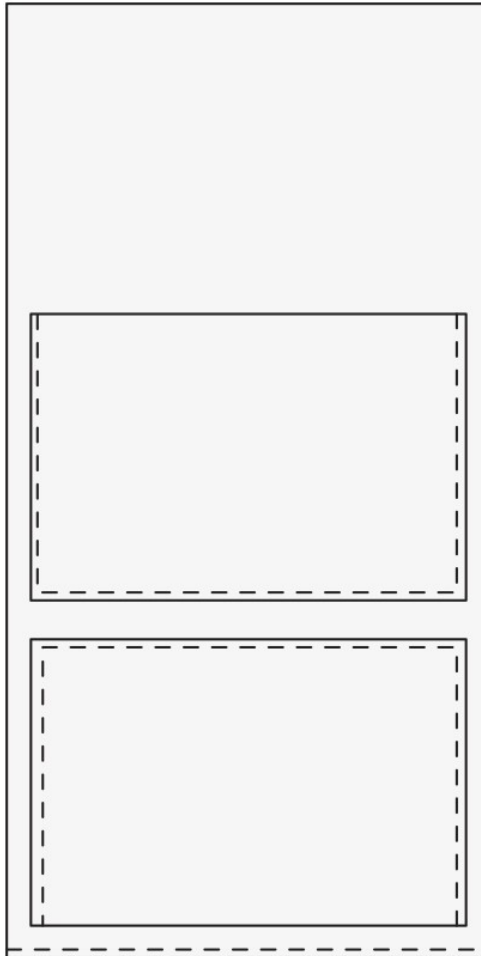

14. Insert plastic snap. Make sure the snap goes inside the pocket and does not attach the pocket to the purse wall.

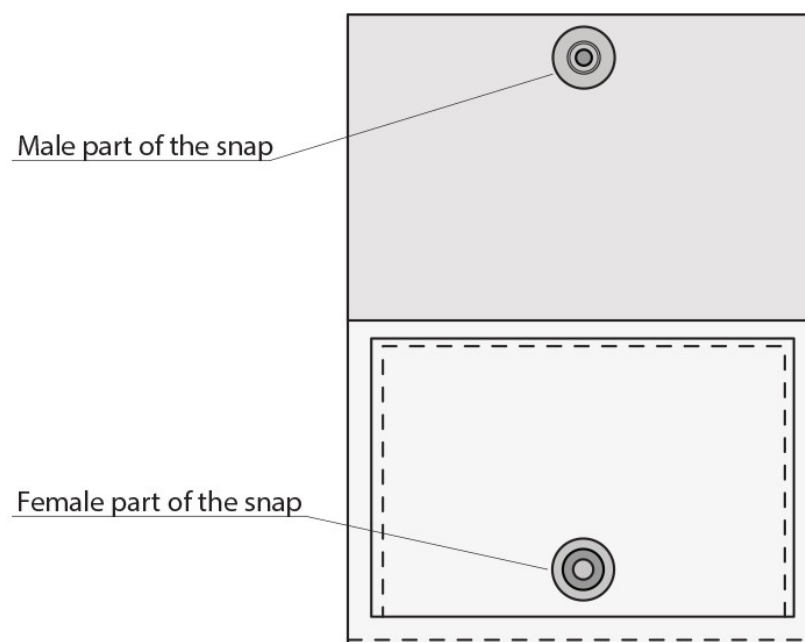

15. You can make button closure instead of the snap if you prefer. Attach the button to the little pocket and make a button hole inside the purse closure.
16. Congratulations! You have finished this project! Please share your results with me! Tag me on social media!

INSTAGRAM [@victoriakonash](https://www.instagram.com/victoriakonash)
FACEBOOK [@vixecodesigns](https://www.facebook.com/vixecodesigns)
<https://t.me/vixecodesigns>

[#zerowastecoinpurse](https://twitter.com/zerowastecoinpurse)

P.S. Because I give all my patterns for FREE I do not always have someone to proof read and check my patterns for any minor drawbacks. So if you come across any or just see room for improvement, please don't hesitate to contact me at vixecodesigns@pm.me