

CUTTING INSTRUCTIONS SIZE 12

Before we start mark top fabric fold line and CF (centre front) line. Your top fabric fold line divides your fabric length into two equal 1m parts and CF line divides your fabric in half lengthwise.

1. NECKLINE. The neckline opening extends to the front and to the back from the top fabric fold line. To draft this we need to temporary shift Fabric Fold line 10cm down – see diagrams below.

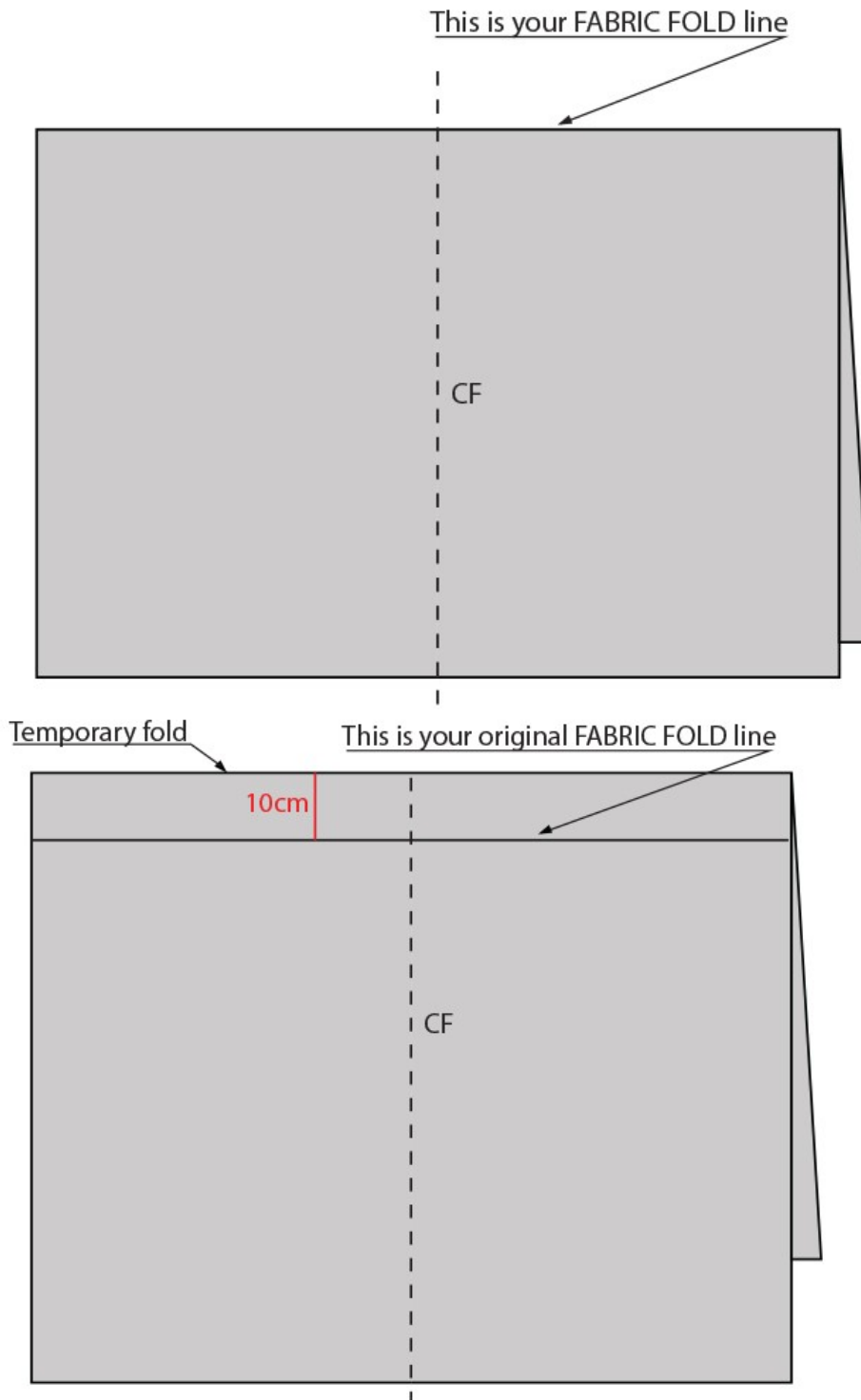

Then draft a straight parallel line 2.5cm above the marked fabric fold line.

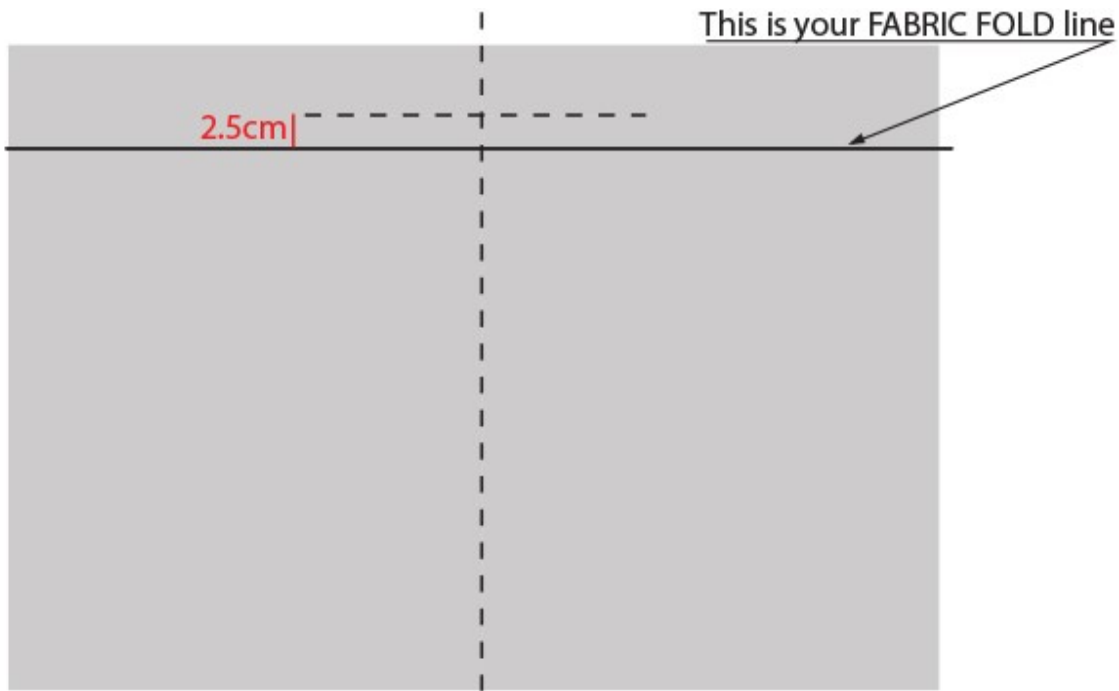

On the line you just drafted, mark two points both 12.75cm away from CF – you will get a line 25.5cm long in total. Then draft two vertical lines down both sides of this horizontal line.

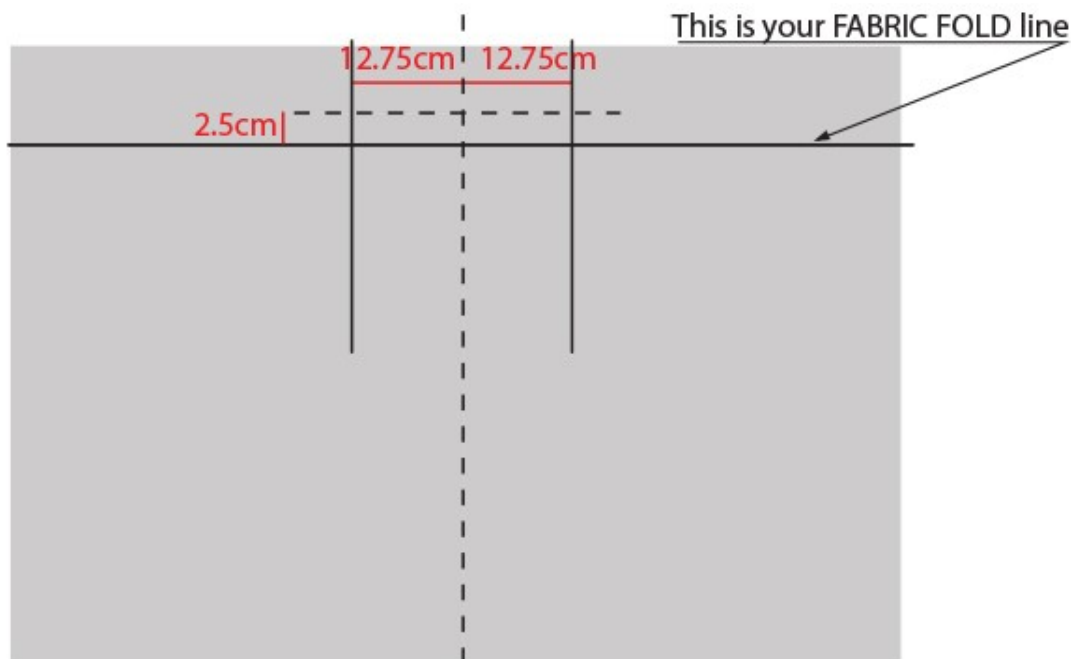

Measure 17cm down from your top horizontal line (or 14.5cm down from your original fabric fold line) and draft another line parallel to the fabric fold line. You will have a rectangle.

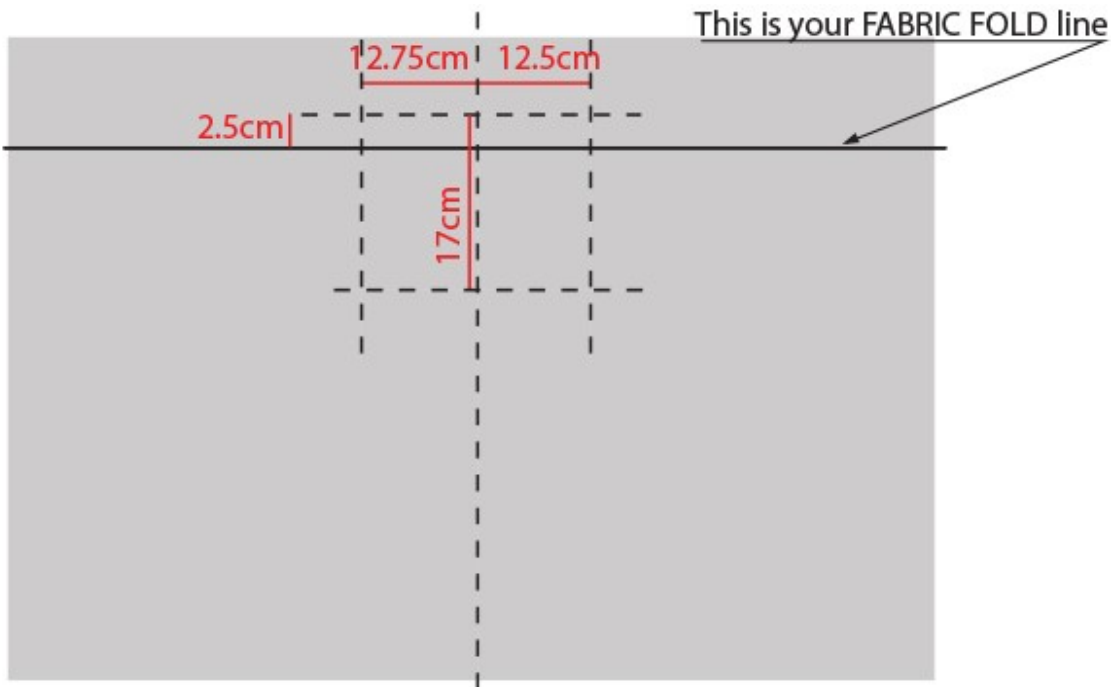

Place a mark 2.5cm towards the centre from each top corner of your rectangle.

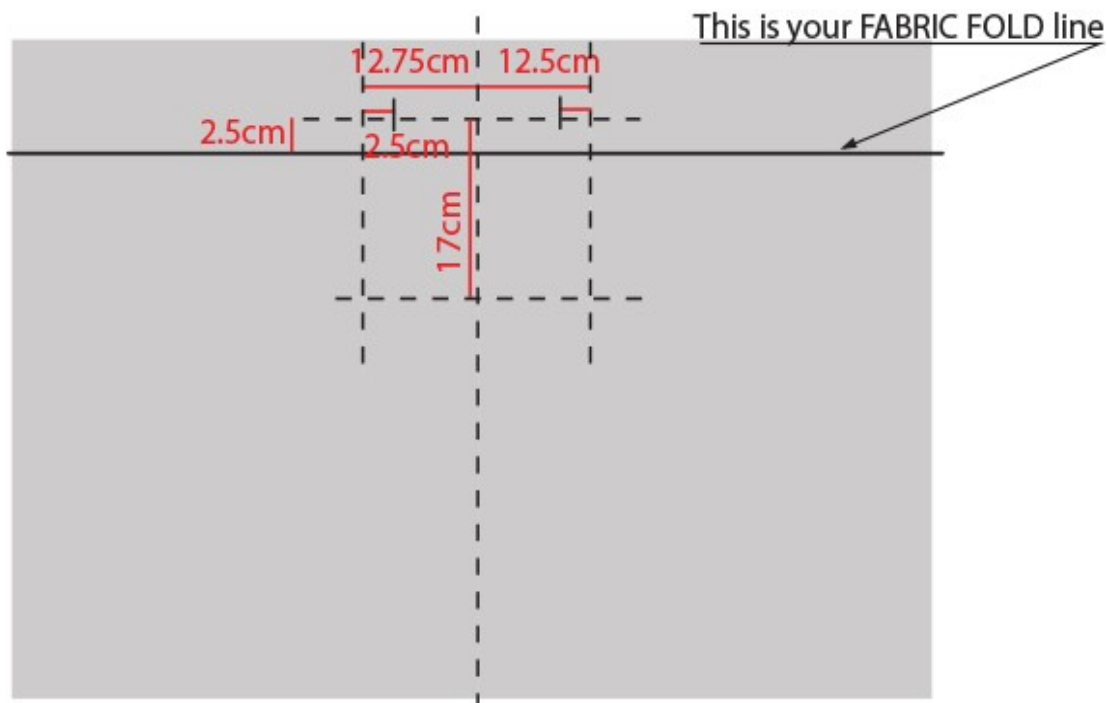

Draft a smooth line from one mark you just made to the other (see diagram below) – this is your neckline opening.

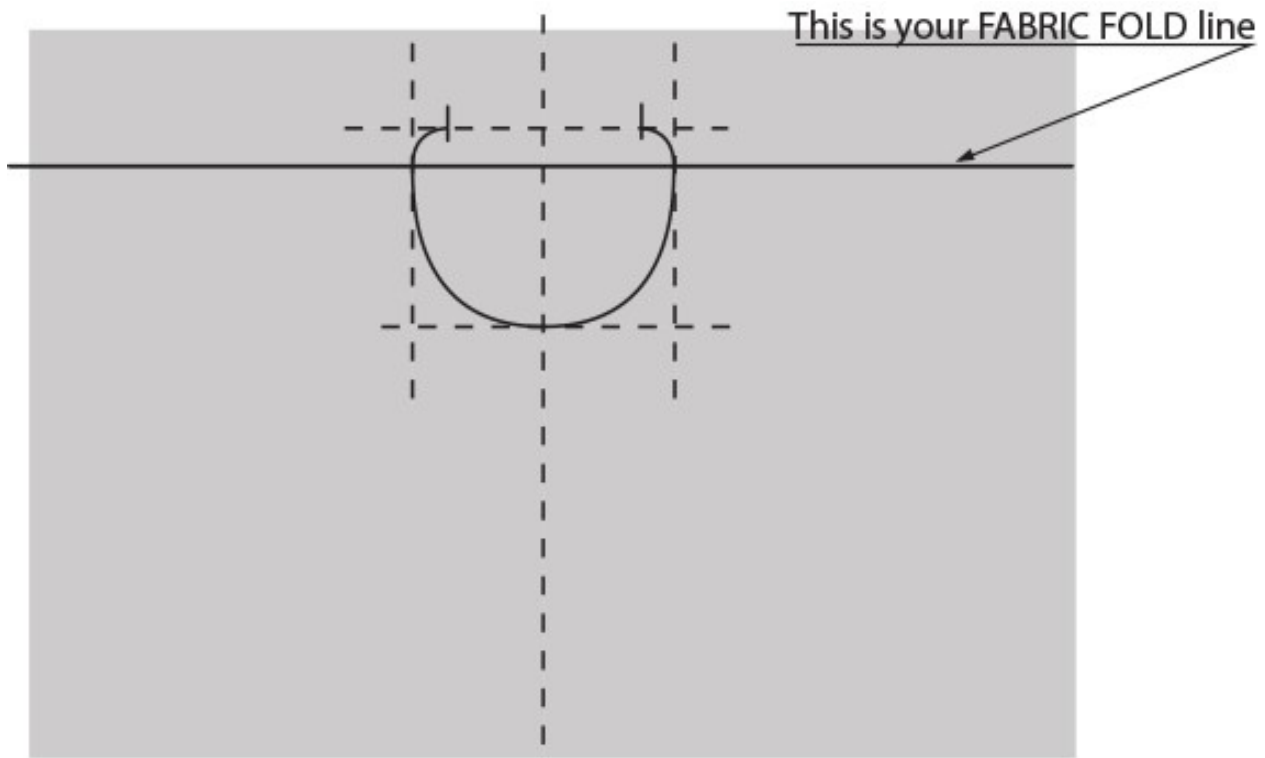

Avoiding the line between the blue marks, cut your neckline open. Make sure the straight line at the top is left uncut. Make a little snip first to create a hole for the scissors, then cut the rest.

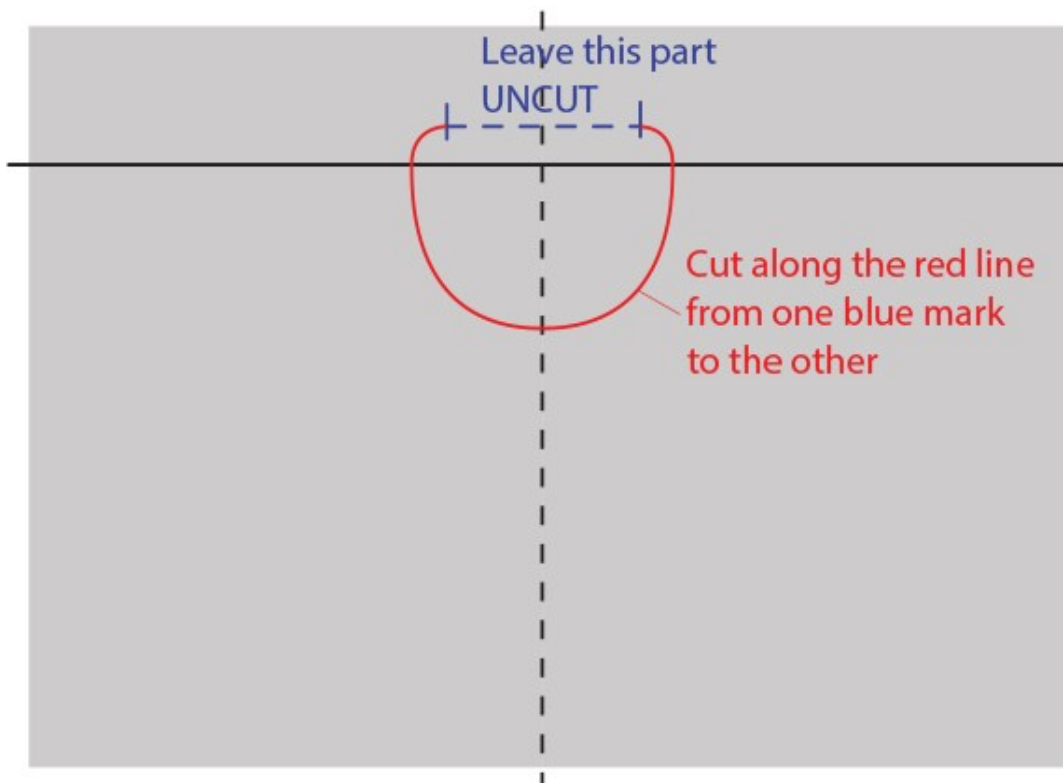

Fold the cut out shape towards the back with wrong sides of fabric facing each other and pin for now. Shift the original fabric fold line back where it was so that your fabric is again divided by it into two equal 1m parts.

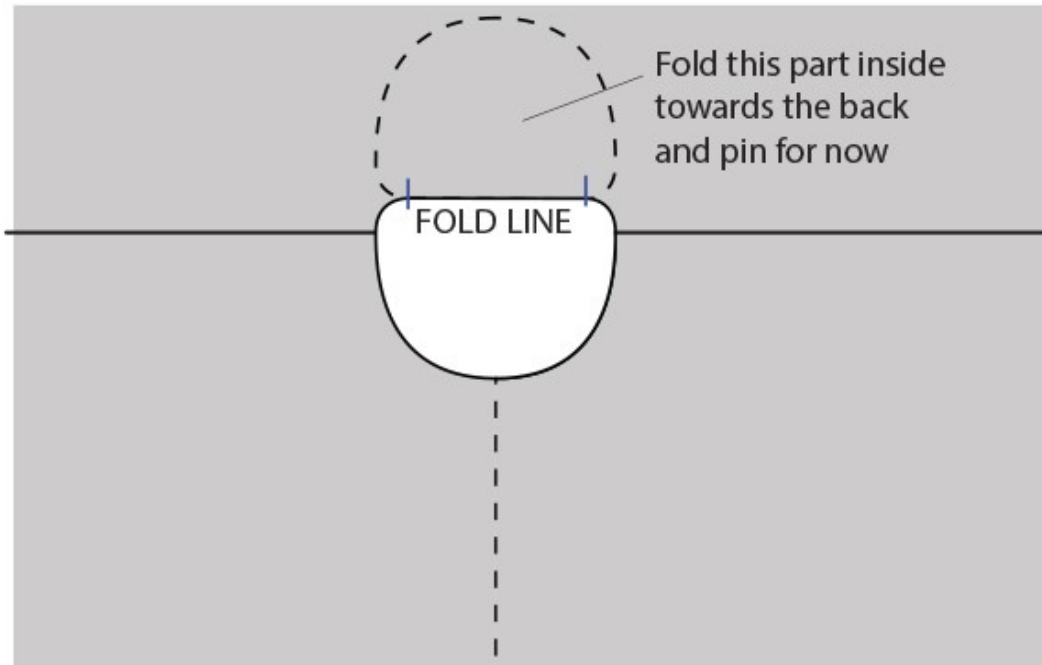

2. SHOULDER AND WAIST LINES. On the fabric fold, mark 11cm to the left and to the right from the neckline opening. Then draft two perpendicular lines 42.5cm long from these two points down.

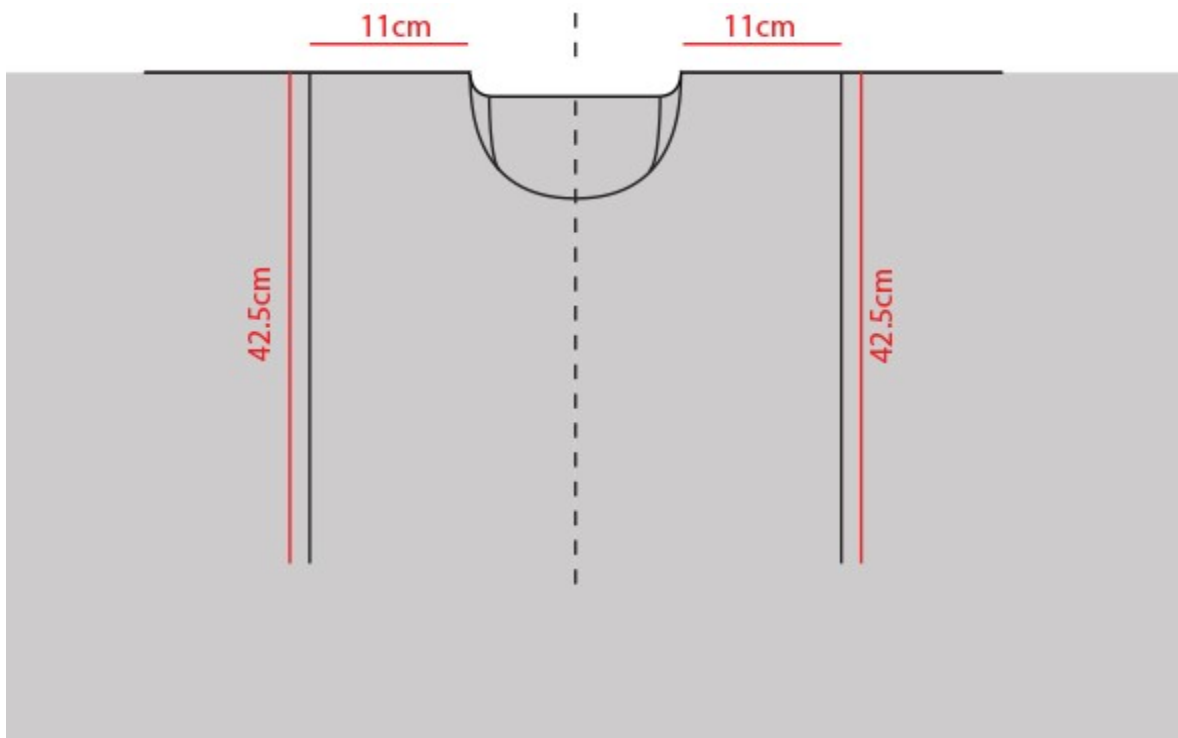

Measure 3cm down from the ends of the shoulders. Mark slanted shoulder lines from these points to the neck line (see diagram).

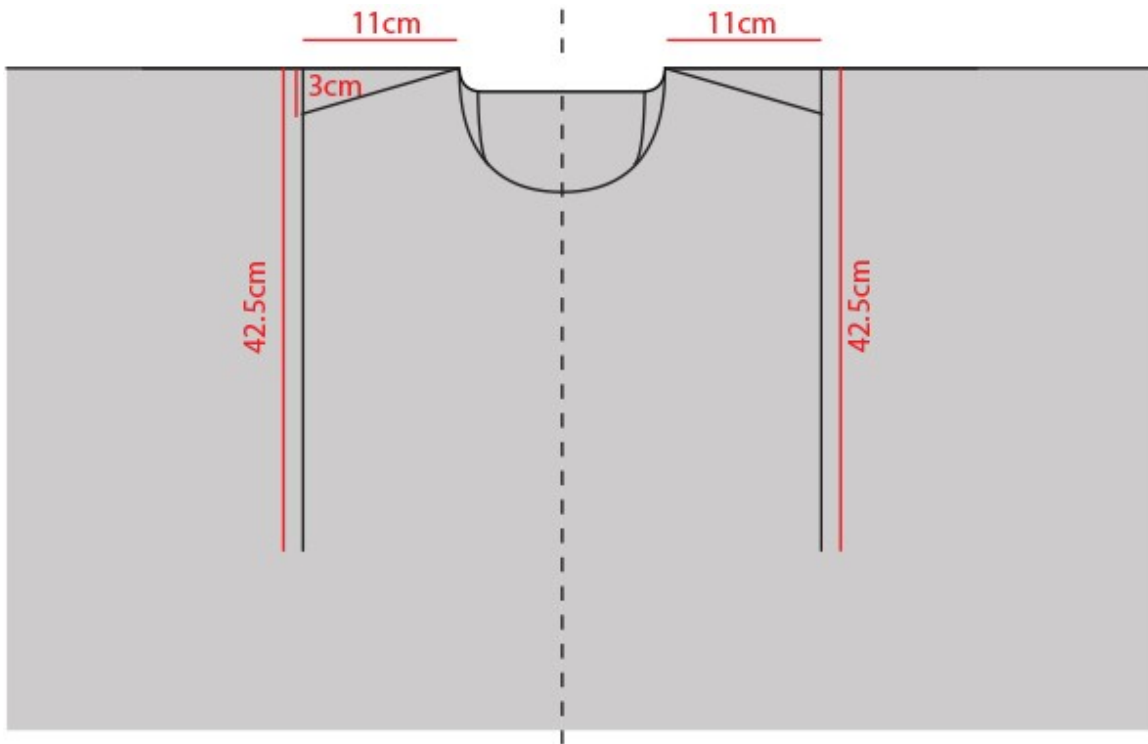

Draft two straight horizontal lines from the ends of the 42.5cm lines all the way to the fabric selvedge (see diagram below).

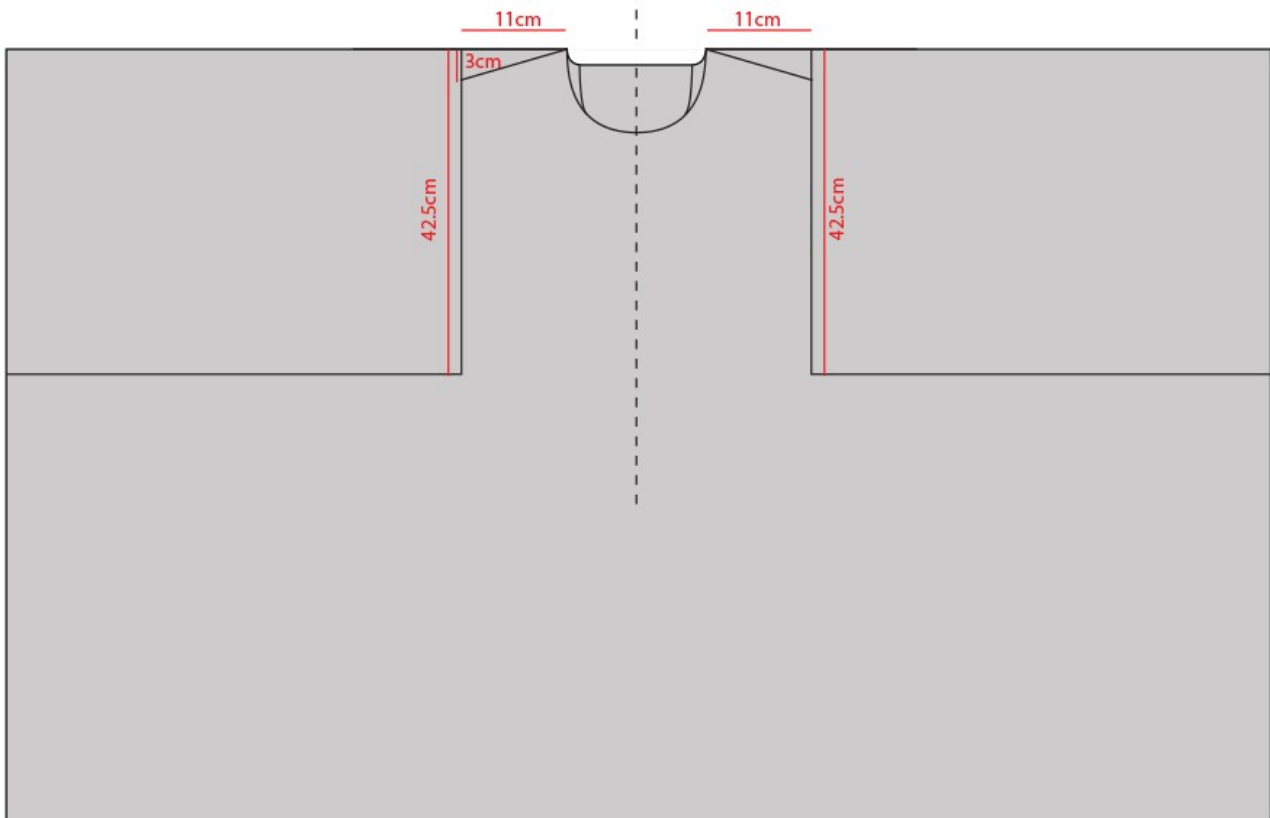

3. FINISHING OFF.

From this point your markings will differ depending on your fabric width. If your fabric width is 160cm wide continue below. If your fabric width is 150cm go to **WIDTH ADJUSTMENT** section on page 11 and continue from there!

Complete the fabric makings by drafting another vertical line 18cm away from the left fabric selvedge. Cut along all the straight lines, you will have 4 fabric pieces – (1) the dress body, (2) sleeve and belt, (3) collar and belt extensions, (4) pockets. Your neckline has been cut already. **DO NOT CUT ALONG THE SHOULDER LINES!**

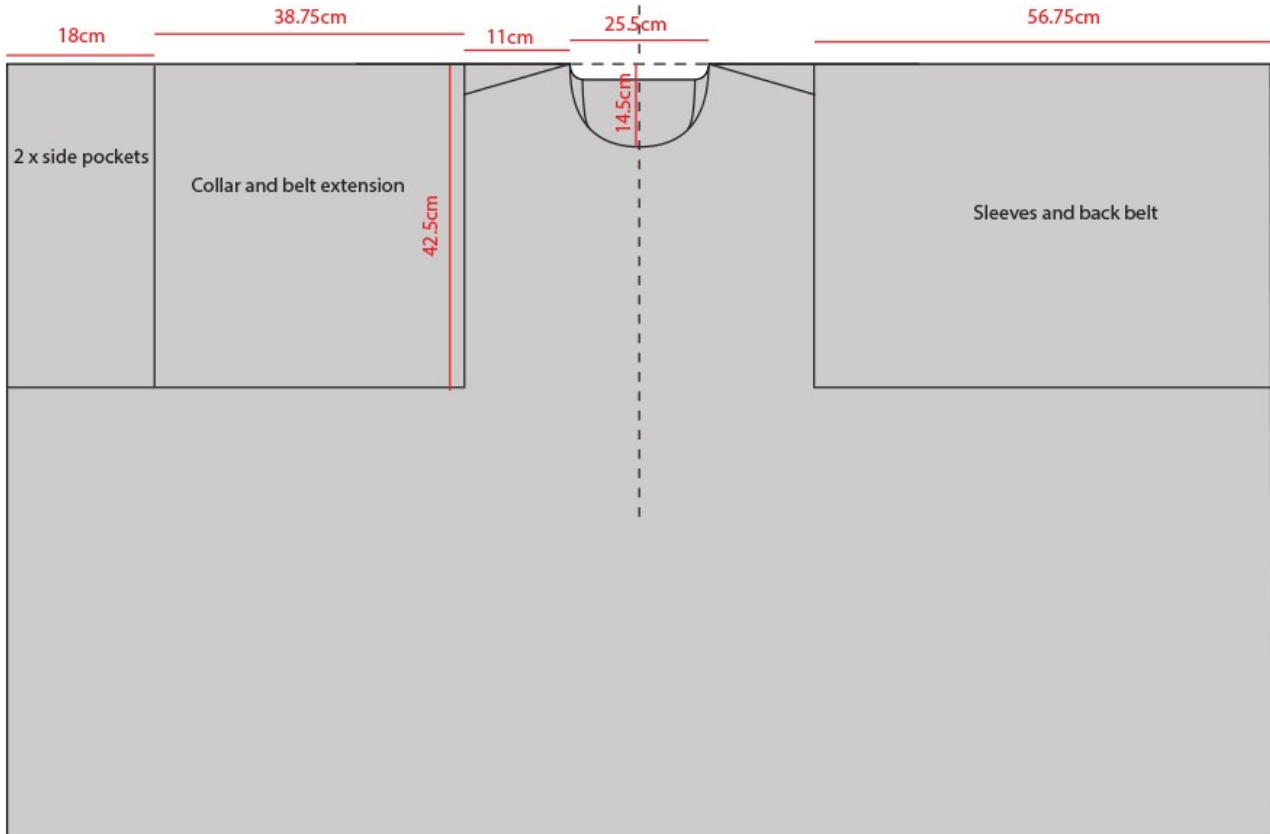

4. POCKETS. Cut along the top fold line of the pockets piece. You will have two equal pieces, each 18cm x 42.5cm.

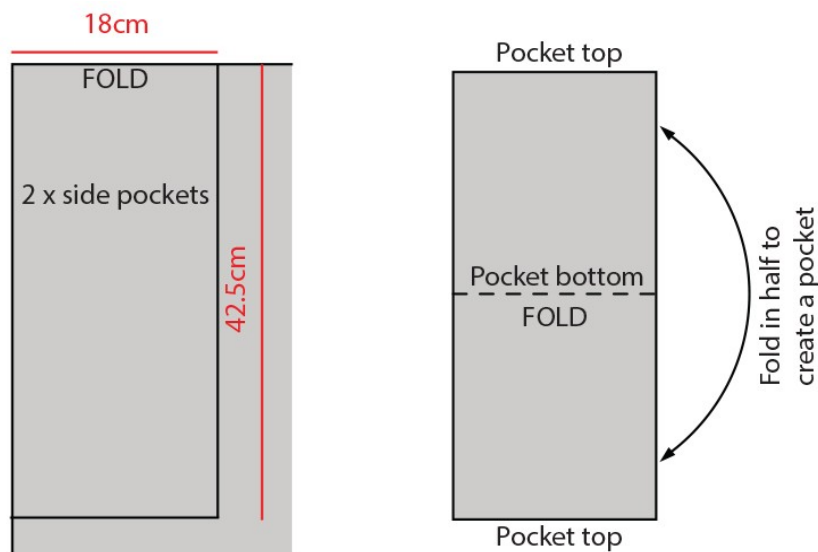

5. COLLAR AND BELT EXTENSION. The collar and belt extension piece is 38.75cm wide and 85cm long (42.5cm on fold).

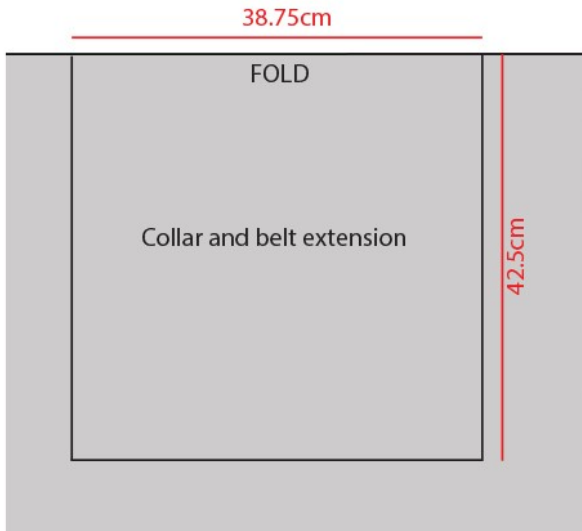

Open it out and lay in front of you horizontally (with the widest edge closest to you). Mark a rectangle 17cm x 38.75cm on one end (see diagram below). Cut this off.

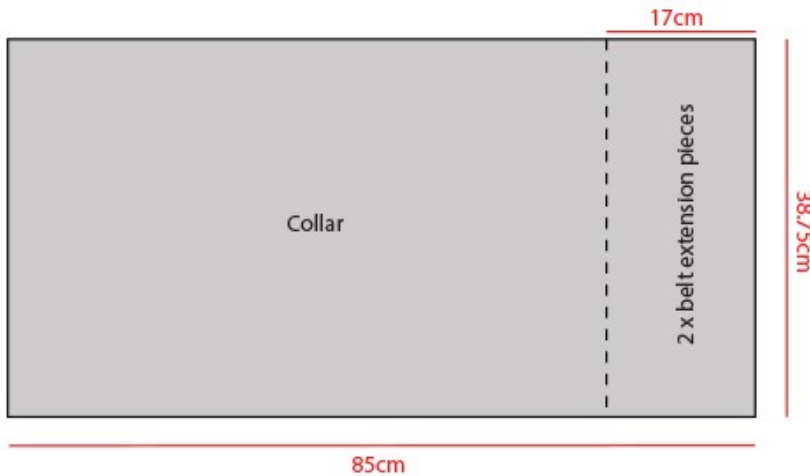

You have two pieces now – a collar piece and the belt extension piece. Cut the belt extension piece in half as shown on the diagram. Put them all aside for now.

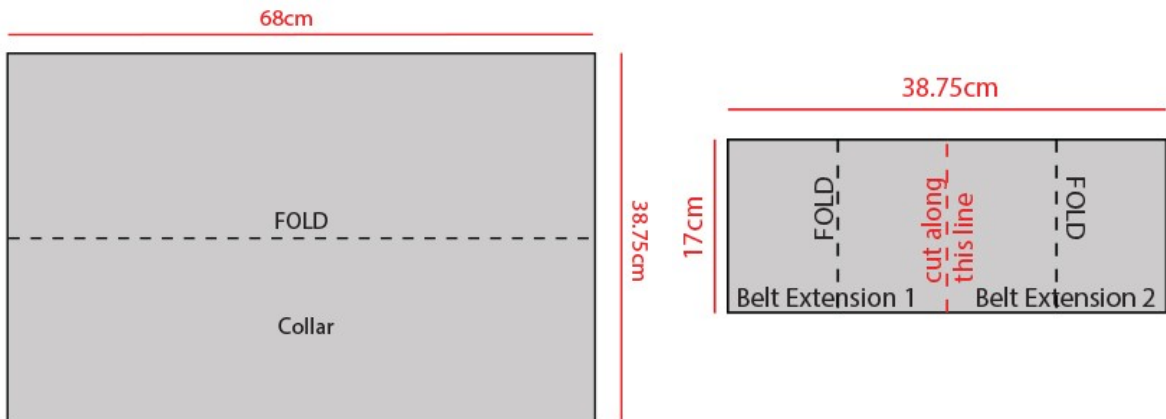

6. **SLEEVES AND BELT.** Your sleeves and belt piece is 56.75cm wide and 85cm long (42.5cm folded in half).

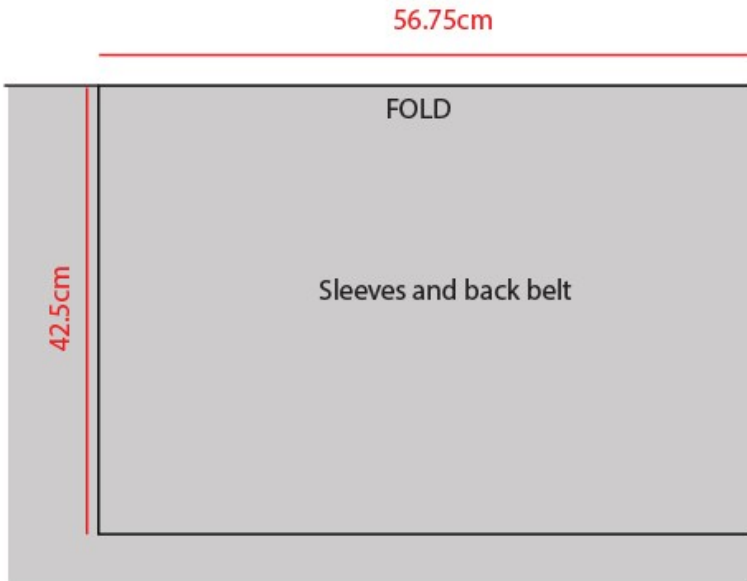

Open the piece up and place in front of you horizontally (with the widest edge closest to you).



Refold it lengthwise as shown in the diagram below.

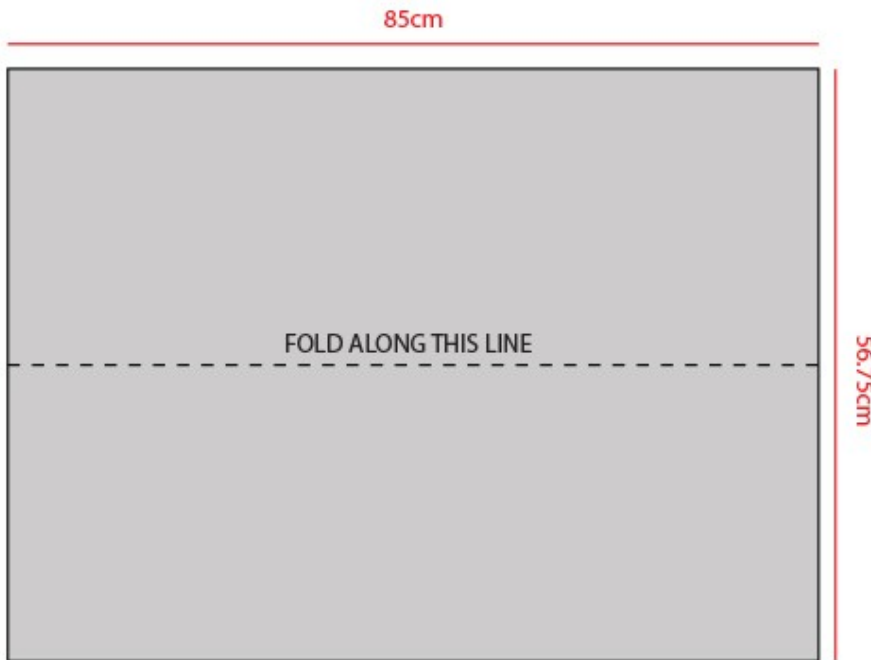

Divide the piece in half lengthwise as shown in the diagram below.



Following the diagram below, finish marking your sleeve and belt parts. Then cut along the marked lines. Cut through both fabric layers. DO NOT CUT ALONG THE FOLD. Proceed to SEWING INSTRUCTIONS from here.

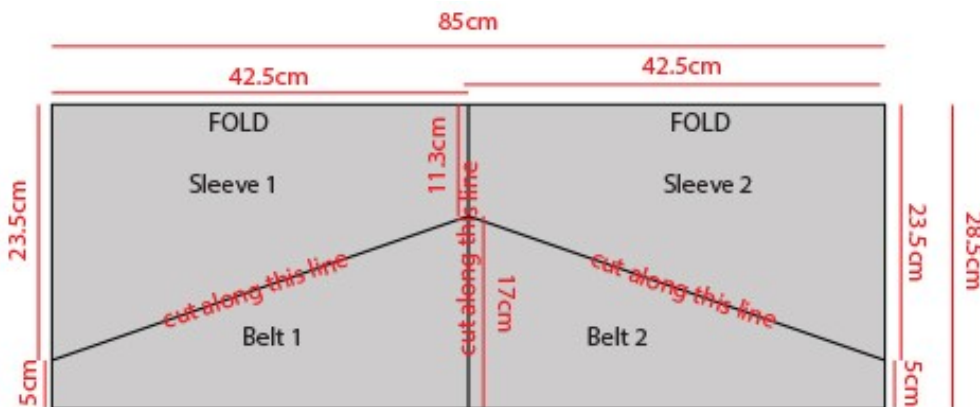

**WIDTH ADJUSTMENTS
for 150cm wide fabric**

3a. FINISHING OFF. Complete the fabric makings by drafting another vertical line 18cm away from the left fabric selvedge. Cut along all the straight lines, you will have 4 fabric pieces – (1) the dress body, (2) sleeve and belt, (3) collar and belt extensions, (4) pockets. Your neckline has been cut already. **DO NOT CUT ALONG THE SHOULDER LINES!**

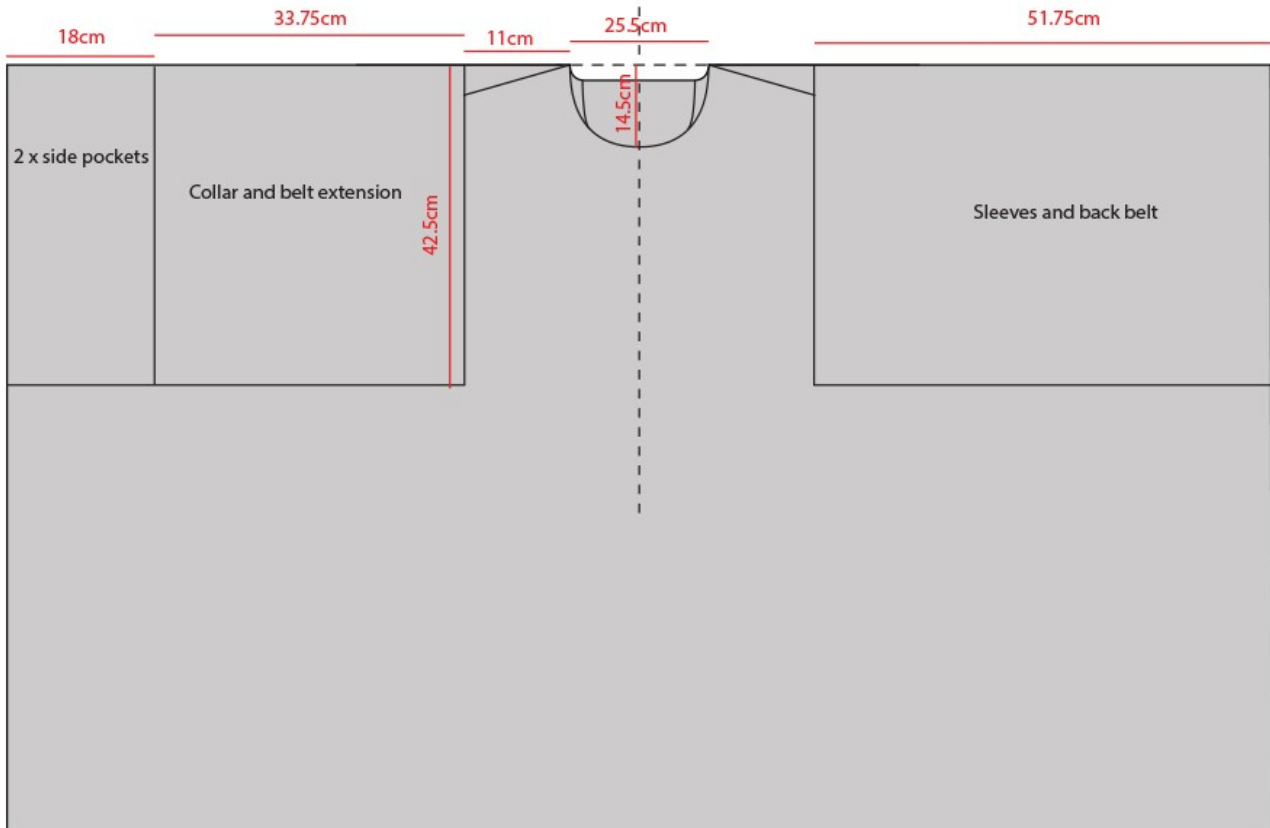

4a. POCKETS. Cut along the top fold line of the pockets piece. You will have two equal pieces, each 18cm by 42.5cm.

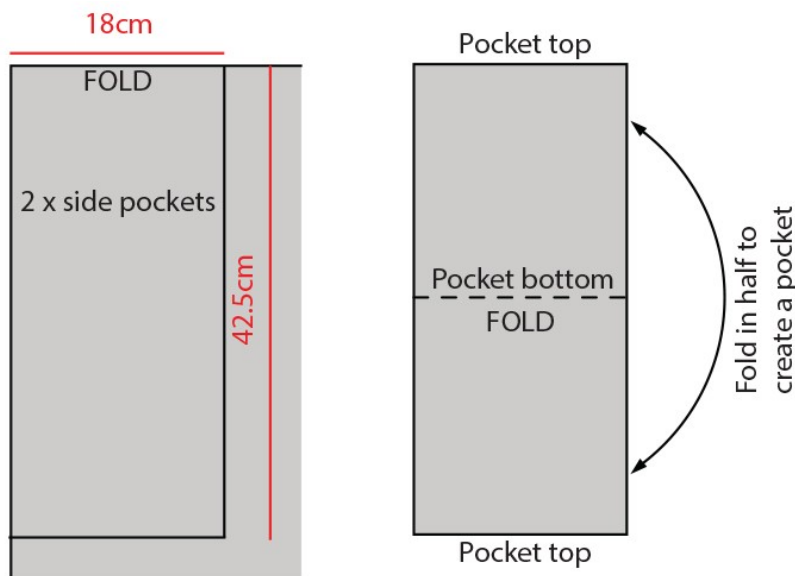

5a. **COLLAR AND BELT EXTENSION.** The collar and belt extension piece is 33.75cm wide and 85cm long (42.5cm on fold).

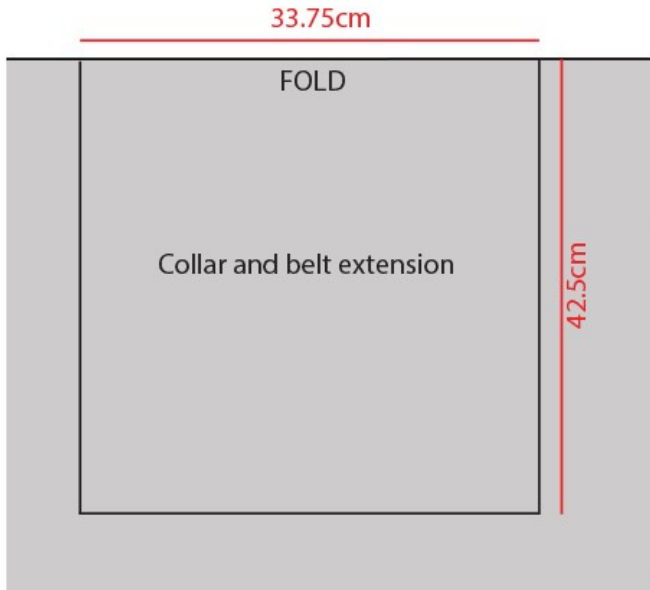

Open it out and lay in front of you horizontally (with the widest edge closest to you). Mark a rectangle 15cm x 33.75cm on one end (see diagram below). Cut this off.

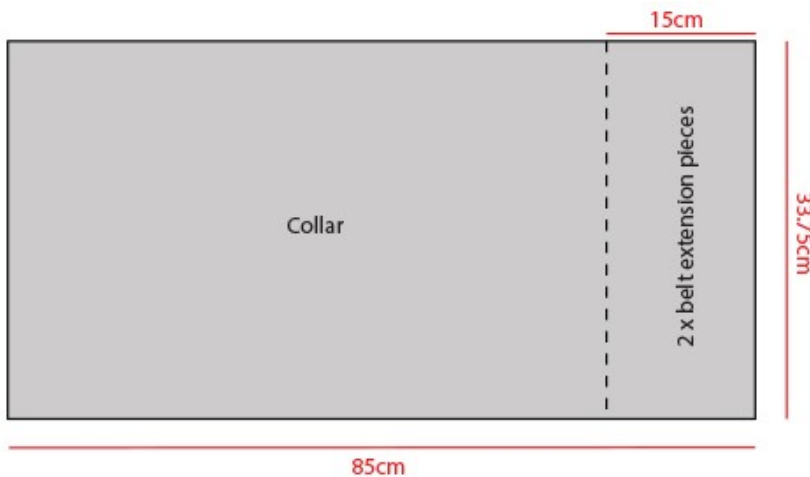

You have two pieces now – a collar piece and the belt extension piece. Cut the belt extension piece in half as shown on the diagram. Put them all aside for now.

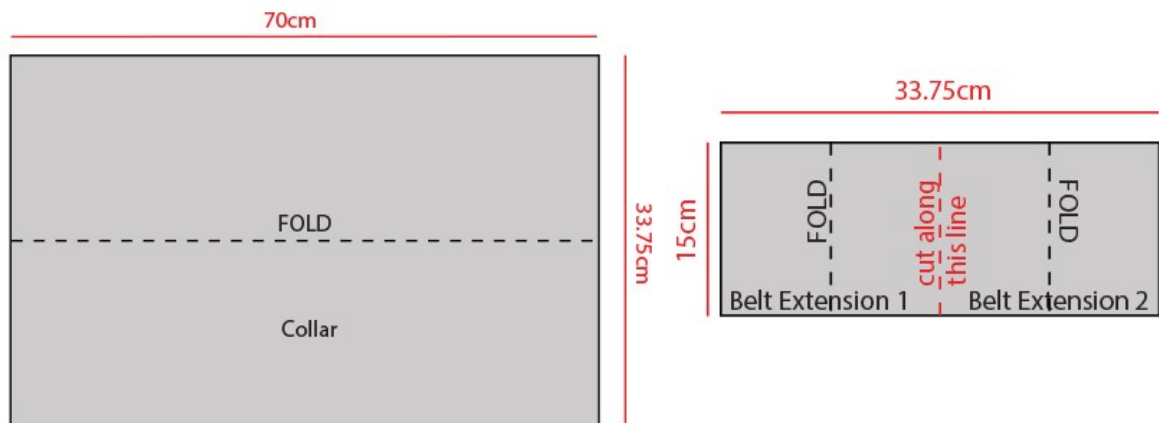

6a. **SLEEVES AND BELT.** Your sleeves and belt piece is 51.75cm wide and 85cm long (42.5cm folded in half).

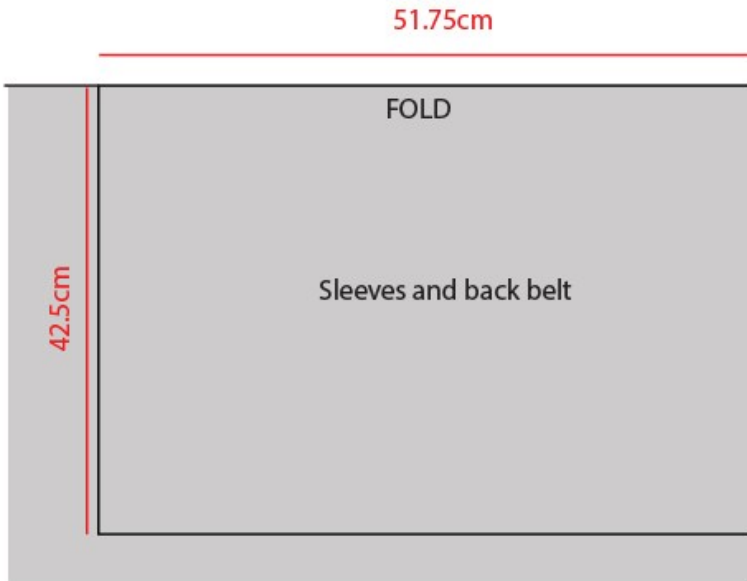

Open the piece up and place in front of you horizontally (with the widest edge closest to you).

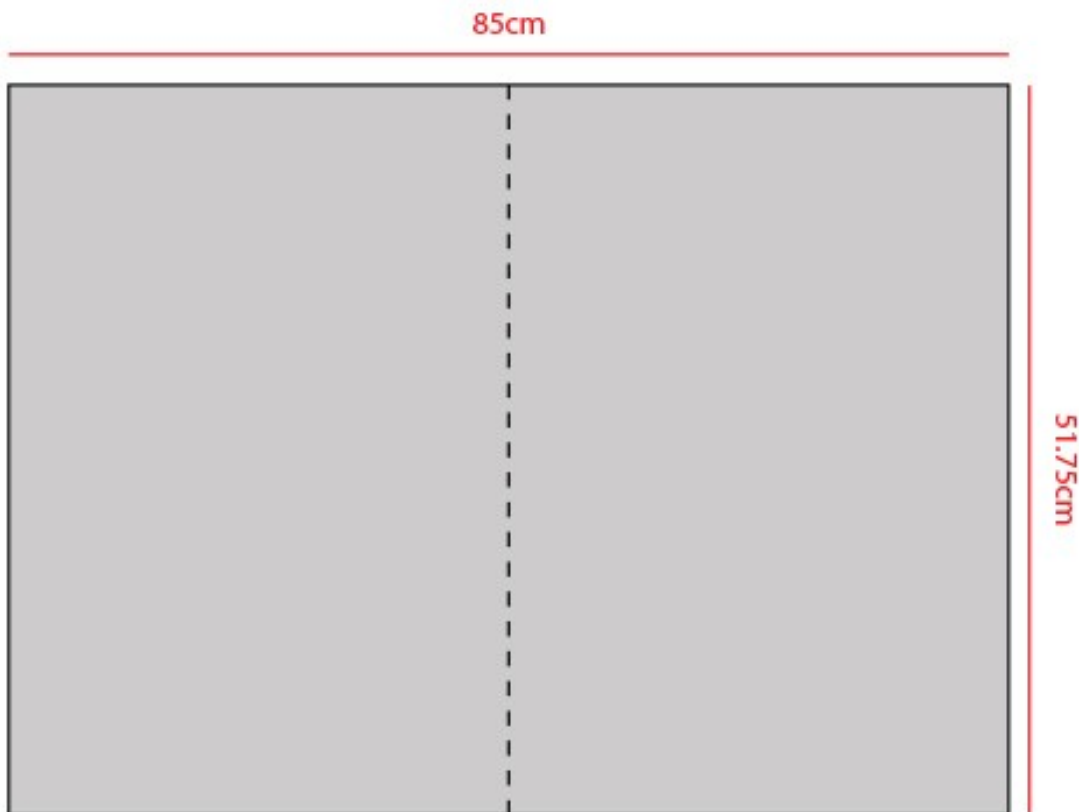

Refold it lengthwise as shown in the diagram below.

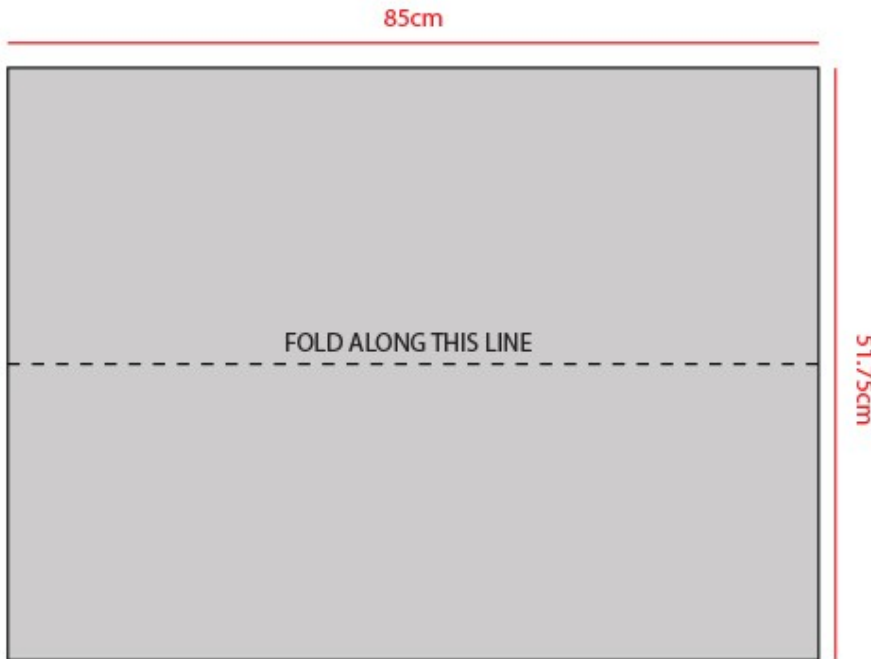

Divide it in half lengthwise as shown in the diagram below.



Following the diagram below, finish marking your sleeve and belt parts. Then cut along the marked lines. Cut through both fabric layers. DO NOT CUT ALONG THE FOLD LINE. Proceed to SEWING INSTRUCTION from here.

